

VCD MP3 CD Soundmachine

AZ5140

User manual

Manual del usuario

Manual do usuário

產品說明書



PHILIPS

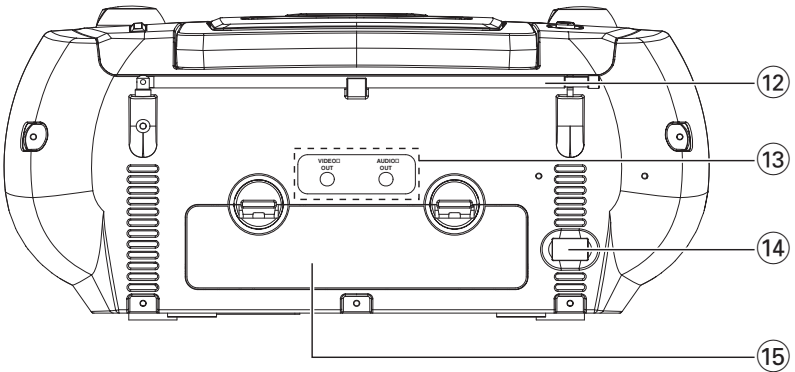
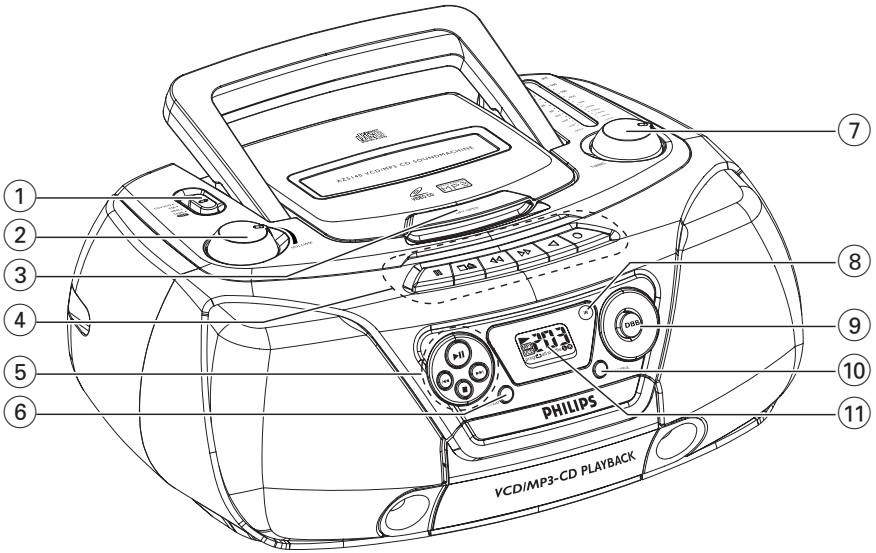

English

MP3 General Information.....	6	CD/VCD/MP3-CD	
Controls	7	11-17
Remote Controls.....	7-8	Cassette recorder	18-19
Power Supply	9-10	Maintenance	19-20
General Operation / Radio	10	Troubleshooting	21

English

Español

Información General sobre MP3	22	CD / VCD / CD - MP3.....	27-33
Controles	23	Grabadora de Cassettes.....	34-35
Controles Remotos	23-24	Mantenimiento	36
Suministro de Corriente	25-25	Detección y Corrección de Fallas....37
Operación General / Radio.....	26		

Español

Português

MP3 Informação Geral	38	CD/VCD/MP3-CD	43-49
Controlos	39	Gravador de Cassetes	50-51
Comando à Distância	39-40	Manutenção	52
Abastecimento de Energia.....	41-42	Resolução de problemas	53
Funcionamento Geral/radiofónica	42		

Português

中文

MP3 一般說明	54	CD/VCD/MP3-CD	
控制鍵	55	59-65
遙控器	55-56	磁帶錄音機.....	66-67
電源供給	57-58	維護保養	67-68
一般操作 / 收音機.....	58	故障排除	69

中文

Dear Customer,

Thank you for buying the Philips MP3-CD Soundmachine. Your great new acquisition will allow you to listen to up to 10 hours of CD-like quality music, using the revolutionary new music compression technology MP3.

MP3 technology

MP3 is short for MPEG1 Layer-3 encoding and decoding technology, a very powerful encoding algorithm with which you can shrink down the original digital audio sound data with a factor of up to 10 without losing significant sound quality.

Recording and Playback

It is recommended to set your recording bit rate to 128kbps, sampling frequency at 44.1kHz to achieve CD-like music playback quality.

Since downloading MP3 files from the Internet, ripping songs from your own legal CD's and burning MP3 songs onto a CD-R, are a delicate process, the quality of a MP3 song may vary by these process. Subsequently, making a MP3-CD may not be entirely perfect.

As a result of the above imperfection, you may experience an occasional "skip" while listening, or an occasional delay in accessing "previous/next" title to MP3-CD's. This is considered to be normal.

A comparison chart is enclosed as below:

Sound Quality	Bit Rate	Approximate Reduction Ratio	Approximate total MP3-CD time	Comment
MW radio	32 kbps	40 : 1	40 hrs	Sound quality significantly affected-not recommended.
FM radio	64 kbps	20 : 1	20 hrs	
Near-CD	96 kbps	15 : 1	15 hrs	Balanced sound quality compression rate.
CD-like	128 kbps	10 : 1	10 hrs	
CD	256 kbps	5 : 1	5 hrs	Compression rate low suggest to play CDs instead.
CD	320 kbps	3 : 1	3 hrs	

CONTROLS

TOP AND FRONT PANEL

- ① **Source selector** - power on/off switch and to select source of sound source:
CD•VCD/MW/FM/TAPE.
- ② **VOLUME** - to adjust volume level.
- ③ **LIFT - OPEN** - to open the CD door.
- ④ **Cassette keys:**
II - to interrupt recording or playback.
■ ▲ - to stop the tape and to open the cassette holder.
◀▶ - to fast wind/rewind the tape.
◀ - to start playback.
● - to start recording.
- ⑤ **▶II** - to start or interrupt CD playback.
■ - to stop playback
◀◀ / ▶▶ - to skip or search a passage or a track
- ⑥ **REPEAT** - to repeat a track/programme/entire CD playback
- ⑦ **TUNING** - to tune to radio stations
- ⑧ **iR** - infrared sensor for remote control
- ⑨ **DBB (Dynamic Bass Boost)** - for a more vivid bass response.
- ⑩ **SHUFFLE** - to play all tracks in random order
- ⑪ **LCD Display** - to show the VCD, MP3 functions and disc status.

BACK PANEL

- ⑫ **Telescopic aerial** - to improve FM radio reception
- ⑬ **VIDEO/AUDIO OUT** - connect to the TV or VCR VIDEO/AUDIO IN
- ⑭ **AC MAINS ~** - socket for mains lead
- ⑮ **Battery door** - to open the battery compartment

SUPPLIED ACCESSORIES

Remote Control1 pc
Mains Cord1 pc
Audio / Video Cable1 pc

REMOTE CONTROL

- ① **OSD** - to switch on/off the on screen display on the TV screen.
- ② **PBC (PLAYBACK CONTROL)** - to switch on or off PBC mode (for VCD version 2.0 only).
- ③ **DIGITS 0 - 9**
for CD/VCD/MP3-CD - to select a track number.
(numbers consisting more than 2 figures must be keyed in within 2 seconds)
- ④ **RETURN** - to return to the previous MENU level during playback (for VCD with PBC on).
- ⑤ **RESUME** - to resume playback in stop mode.
- ⑥ **STOP ■**
- to stop playback or to clear a programme.
- ⑦ **ZOOM**
for VCD only to zoom in or zoom out picture.
- ⑧ **GOTO** - to start playback at any chosen time on the disc (for CD/VCD operation only and PBC mode is off).

- ⑨ **▶||**
- to start or interrupt playback.
- ◀◀▶▶**
for MP3-CD only to select previous/next title.
- for CD/VCD to search backward/forward track.

- ALBUM+/-**
for MP3-CD only to select previous / next album
- ⑩ **◀◀ / ▶▶** (for CD/VCD/MP3-CD)
- to search back or forward.
- ⑪ **SHUFFLE** - When in CD/VCD mode, press to start or stop shuffle play mode (for VCD, only available in PBC off mode)
- ⑫ **REPEAT**
for MP3-CD to repeat a track, or whole disc.
for CD/VCD to repeat a disc track or the whole disc.
- ⑬ **A - B** - to playback a certain scene or passage repeatedly (for CD/VCD operation only).
- ⑭ **R/L/ST** - to select channel left / channel right / stereo sound, or to select a language in a bilingual VCD.
- ⑮ **SLOW** - to watch a VCD at a slower speed (for VCD operation only).
- ⑯ **PROG**
for CD/VCD/MP3-CD to programme disc tracks.
- ⑰ **VIEW** - to scan through a VCD with 9 pictures display on TV screen.
- ⑱ **NTSC/PAL** - to select the video output for NTSC or PAL system.
- ⑲ **MIX/SEL** - to select disc format (CD / MP3-CD) in a mixed mode disc.

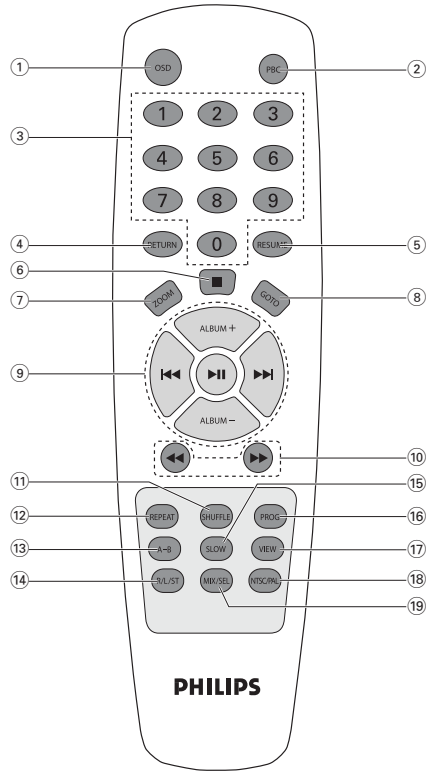

POWER SUPPLY

IMPORTANT!

- For best CD/MP3-CD/VCD playback, please plug in your set to an AC power supply where convenient.
- If operated in DC mode, see below approximate playtime. (Playtime is also varied from different brand batteries) :

Battery type	Playtime
Alkaline	approximate 9 hrs
Zinc Carbonate	approximate 45 minutes

- The CD part of this system also serves as a Video CD player if you connect it to your TV set.
- Before viewing the Video CD, ensure that the set is switched to corresponding PAL or NTSC system of your TV set (exception Multi-system TV).

BATTERIES (NOT SUPPLIED)

Whenever convenient, use the mains supply if you want to conserve battery life. The battery supply will be switched off when the set is connected to the mains. Make sure you remove the plug from the set and wall outlet before inserting batteries.

Batteries

1. Open the battery compartment and insert six batteries, type **R14, UM2** or **C-cells, (preferably alkaline)** with the correct polarity as indicated by the "+" and "-" symbols inside the compartment.

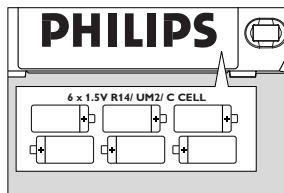

Remote control

1. Open the battery door and insert two batteries, type **AAA, R03** or **UM4** (preferably alkaline).
2. Replace the compartment door, making sure the batteries are firmly and correctly in place.
3. Remove the batteries if they are exhausted or if they will not be used for a long period.
 - The incorrect use of batteries can cause electrolyte leakage and will corrode the compartment or cause the batteries to burst. Therefore:
 - Do not mix battery types, e.g. alkaline with zinc carbonate.
 - When inserting new batteries, replace all at the same time.
 - Remove the batteries if the set is not to be used for a long time.

Note :

- The battery supply is switched off when the set is connected to the mains.

TV screen is disabled during CD / MP3-CD playing if your AZ5140 is battery powered.

Batteries contain chemical substances, so they should be disposed of properly.

MAINS

1. Check if the mains voltage as shown on the type plate (on the bottom of the set) corresponds to your local mains voltage. If it does not, consult your dealer or service organization.
2. Connect the mains lead to the **AC MAINS ~** socket and the wall socket.
→ The set is now ready for use.
3. To switch off the mains supply completely, pull the mains plug out of the wall socket.
→ Disconnect the mains lead when you change over to battery supply, or to protect the set during heavy thunderstorms.

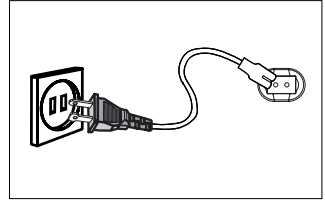

The type plate is located on the bottom of the set.

GENERAL OPERATION

1. To switch on the set, adjust the source selector.
2. Adjust the sound using the **VOLUME** and **DBB** controls.
3. To switch off the set, adjust the source selector to the **TAPE/OFF** position, with the cassette keys released.

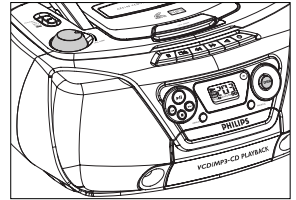

RADIO RECEPTION

1. Set the source selector to **FM** or **MW**.
2. Adjust the sound using the **VOLUME** controls and the **DBB** switch.
3. Tune to a radio station using the **TUNING** knob.
 - For FM, pull out the telescopic aerial. To improve FM-reception, incline and turn the aerial. Reduce its length if the FM-signal is too strong (very close to a transmitter).
 - For MW, the set is provided with a built-in aerial, so the telescopic aerial is not needed. Direct the aerial by turning the whole set.
4. To switch off, set the source selector to the **TAPE/OFF** position (with the cassette keys released).

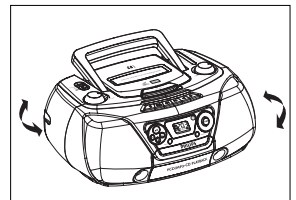
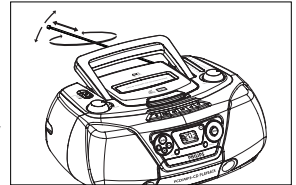

CD/VCD/MP3-CD

CAUTION

Use of controls or adjustments or performance of procedures other than herein may result in hazardous radiation exposure or other unsafe operation.

Environmental information

All unnecessary packaging material has been omitted. We have done our utmost to make the packaging easily separable into three mono materials: cardboard, polystyrene and plastic.

Your set consists of materials which can be recycled if disassembled by a specialized company. Please observe the local regulations regarding the disposal of packaging materials, exhausted batteries and old equipment.

DISCS FOR PLAYBACK

This set can play all digital audio CD, video CD, finalised digital audio CD-Recordable (CDR) discs and finalised digital audio CD-Rewritable (CDRW) discs.

Support following MP3-CD formats:

- ISO 9660 or ISO 9660 + Joliet format - Max. 30 characters
- Max. Track number is 400
- Max. nested directory is 8 levels
- The max. album number is 99
- The max. MP3 programme track number is 20
- The max. length of each track is 99 minutes 59 seconds
- The player can play mixed mode disc of CD / MP3-CD
- Supported VBR bit-rate
- Supported sampling frequencies for MP3 disc : 8 kHz to 48 kHz (44.1kHz preferably)
- Supported bit-rates of MP3 disc are: 32 - 320 kbps (128 kbps preferably)



Following formats are not supported

- The files like *.WMA, *AAC, *.DLF, *.M3U, *.PLS, MP3 PRO and JPEG CD
- The non-session closed discs

LOADING A DISC

1. Set the source selector to **CD/VCD**.
2. Lift to open the CD door.
→ "CD" will be displayed
3. Insert a disc with the label side facing up.
4. Close the CD door.
→ The total number of tracks of the disc appear on the display.
→ "00" will be displayed if no disc is inserted or error in CD operation



For MP3-CD only

→ The total track number "xxx" and album number "Rxx" will be displayed interchangeably.

→ On TV screen, the album list is displayed (max. 10 lines per page). The current selected music is highlighted.

Notes : - To ensure good system performance, wait until the disc completely reads before proceeding.

- For MP3-CD, the disc reading time may exceed 1 minute due to the large number of songs compiled into one disc.

PLAYING A NORMAL DISC

1. Press **▶||** to start playback.
 - The track number of the current track and **▶** appear on the display.
- To interrupt playback, press **▶||**.
 - **▶** will disappear and the current track number will start flashing.
- To resume playback, press **▶||** again.
2. To stop playback, press **■**.



SELECTING A DESIRED TRACK/PASSAGE

To select a desired track

- Press **◀◀** or **▶▶** on the set repeatedly (or use digits 0 - 9 buttons on the remote control) until the desired track appears on the display.
- If playback is stopped, press **▶||** to start playback.

To search for a particular passage during playback

1. Press and hold **◀◀** or **▶▶** on the set.
 - During searching, the volume will be muted.
2. When you recognize the passage you want, release the **◀◀** or **▶▶** button.
 - Normal playback resumes.

For MP3-CD only

To select a desired album

- On the remote control, press **ALBUM+** or **ALBUM-** until the desired album number appears on the display.
 - "A x x" will be displayed.
 - On TV screen, the selected album will be highlighted.

To select a desired track

- Press **◀◀** or **▶▶** on the set repeatedly (or on the remote control, press **◀◀** or **▶▶**) to select a desired track from the current album.
 - "x x x" will be displayed.
 - On TV screen, the selected track will be highlighted.
- Use the digital keys on the remote control to select the track under current album directly.

To select and playback another track during playback mode

1. Press **◀◀** or **▶▶** repeatedly to select another track.
 - The new selected track will show on the display screen and TV screen and playback continuously.

For VCD only

- Either press **◀◀** or **▶▶** on the remote control repeatedly to select fast search speed (x1, x2, x3 or x4) or press & hold **◀◀** or **▶▶** on the set for 1 second and then release **◀◀** or **▶▶** to select fast search speed (x1). Repeat this step to select other speed (x2, x3, x4).

PROGRAMMING TRACKS

Programming tracks of disc is possible only when playback is stopped. Up to 20 tracks can be stored in the memory in any order.

For CD only

1. In stop mode, press **PROG** (on remote control) to enter programme setting.
→ **PROG** will flash on the display.
2. Press **digits 0 - 9** on the remote control or **◀/▶** to select the desired track.
3. Press **PROG** to store the select track. The number "×××" represents the track no.
 - Repeat steps **1** to **3** to store other tracks.
4. Press **■** to end programme setting.
→ **PROG** will remain on the display.
 - Press **PROG** (on remote control) in stop mode to review the programme sequence.
5. Press **▶II** to play the programmed tracks.
 - If you press **REPEAT** during programme playback, the current track or all programmed tracks will be played repeatedly.
→ **REPEAT/REPEAT ALL** icon and **PROG** will appear on the display.
6. Press **■** in stop mode to clear the programme.
→ **PROG** will disappear from the display.

Notes : -The programming is automatically cleared as soon as the CD compartment is opened.
- The function of programme setting is disabled in PLAY/PAUSE mode.

For MP3-CD only

1. In stop mode, press **PROG** on the remote control to enter programme setting.
→ **PROG** will start flashing and "P□!" will be displayed.
→ On TV screen, "PROG" program list (5 lines per page) will be displayed.
2. Press **digits 0 - 9** on the remote control or **ALBUM+/-** to select the desired album.
3. Press **PROG** to store the selected album. The number "P××" represents the album no.
4. Press **◀/▶** repeatedly (or **digits 0 - 9** on the remote control) to select the desired TRACK for programming.
5. Press **PROG** to store the selected track.
→ **PROG** will remain flashing on the display.
 - Repeat steps **1** to **5** to store other desired album and track.
6. Press **■** to end programme setting.
 - To review programme, press **PROG** repeatedly in stop mode.
→ P×× indicates a programme sequence. P×× indicates an album number. ××× indicates a programme.
7. Press **▶II** to start programme playback. You can press **◀/▶** to select the programmed track to play.
8. Press **■** **once** to stop programme playback, or **twice** to clear the programme.

SHUFFLE



You can play all the tracks in random order.

1. During playing, pause or stop mode, press **SHUFFLE** to enable SHUFFLE play mode.
→ **SHUFFLE** will appear on the display.
2. To exit shuffle mode, press **SHUFFLE** again or **■**.
→ **SHUFFLE** will disappear from the display.

Note : - If the Shuffle function is enabled, then the Repeat function is set on, it will disable the Shuffle play mode.
- The shuffle function is not available in the programme playback.

REPEAT

You can play the current track or the whole disc repeatedly.

1. During CD/ MP3-CD playing or pause mode, press **REPEAT** on the remote control or on the set.
→ **REPEAT** icon  - to repeat the current track.
→ **REPEAT ALL** icon  - to repeat the whole disc.
2. To exit the repeat mode, press **REPEAT** until the **REPEAT/REPEAT ALL** icon disappears from the display.

Notes : - If the Repeat function is enabled, then the Shuffle function is set on, it will disable all the Repeat play modes.
- If the Repeat function is enabled, then the Stop button is pressed, it will disable all the Repeat play modes.

VIDEO CD

Adjusting the TV System

Before viewing the Video CD, ensure that the set is switched to corresponding PAL or NTSC system of your TV set (exception Multi - system TV).

1. On the remote control, press **NTSC/PAL** to switch between NTSC and PAL TV system.

OSD - On Screen Display

If you insert VCD/CD, your TV screen will serve as an additional display for messages (e.g. PLAY, STOP), and information stored on the VCD/CD.

- Press **OSD** on the remote control to select viewing various information.
→ The current track and current /elapsed time in the track/disc appear on the display.

VIDEO CD

Playing a Video CD with PBC

PBC (Playback Control) is a predefined play sequence stored on the VCD. PBC feature is only available for 2.0 version VCD.

1. Switch on the TV, then insert a VCD with PBC.
2. Menu appears on the TV screen. If not, press **PBC** on the remote control to display Menu.

If the menu consists of a list of titles, you can select a sequence directly

1. Press **digits 0 - 9** on the remote control to select your choice.
→ The VCD starts playing the selected sequence automatically.
 2. Press **RETURN** on the remote control to go back to the Menu.
- Note** : - If a menu consists of more than one page, press **◀◀/▶▶** to go through the pages.

Switching off PBC

- Press **PBC**.
→ On TV screen, "PBC OFF" will be displayed shortly.

Notes : - The menu structure depends on the programme stored on the VCD. Please refer to the information supplied with the disc.

Pause

1. During playback, press **▶||** to have a still picture on the TV screen.
→ The sound will be muted.
→ On TV screen, "PAUSE" will be displayed.
2. Press **▶||** again to continue playback.

Goto

1. Press **GOTO** on the remote control.
→ On TV screen, "GOTO --:--" will be displayed.
2. Press **digits 0 - 9** on the remote control to key in the disc time from which you want the disc to begin playback.

Notes : - The disc time entered should not be greater than the total disc time.
- Goto mode is not available whenever PBC mode is switched on.

Slow

1. Press **SLOW** on the remote control to watch a VCD at a slower speed. There are 4 types of slow modes to select.
→ The sound will be muted.
→ On TV screen, "SLOW 1/2", "SLOW 1/4", "SLOW 1/8" or "SLOW 1/16" will be displayed.
2. To resume playback at normal speed, press **SLOW** repeatedly until "PLAY" appears on the TV screen or press **▶||**.

A-B repeat

This feature is also applicable to audio CD (except for MP3-CD), offering to play a certain scene or passage of the disc repeatedly.

VIDEO CD

1. Press **A-B** on the remote control during playback to mark the start point of the chosen scene or passage.
→ "**REPEAT A**" will appear on the screen.
2. Press **A-B** again to mark the end of the chosen scene or passage.
→ "**REPEAT AB**" will appear on the screen.
→ The selected scene or passage will start playing repeatedly.
3. Press **A-B** once more to return to normal playback.
→ "**REPEAT AB**" will disappear from the display.

Notes : - You can also cancel A-B repeat by pressing **◀◀** or **▶▶**.

- A-B repeat marking can cross from one track to another. But for VCD 2.0, you are only able to set the A-B repeat marking within the same track.

Resume

- In stop mode, press **RESUME** on the remote control to start playback again from where you have stopped.

Note : - Resume will not be available if you have changed the disc, opened the disc tray or disconnected the system from the power supply.

View

This feature allows you to scan through a VCD for a quick review.

1. In stop mode, press **VIEW** on the remote control to go to disc view function.
→ On TV screen, up to 9 pictures will be displayed. If a menu consists of more than one page, press **◀◀** or **▶▶** to view the previous/next page.
→ The first several seconds of each track will be played.
To exit review mode, press **digits 0 - 9** to play the desired track or **▶||** to play the current selected track.
2. In playback mode, press **VIEW** on the remote control to go to track view function.
→ press **◀◀** or **▶▶** to select the track.
→ On TV screen, up to 9 pictures within the track will be displayed.
→ The first several seconds of each picture will be played.
To exit review mode, press **digits 0 - 9** to play the desired position within the track, or **▶||** to play the current selected position.

Note : - If the disc is AVCD disc and there're no video tracks on the same viewed page, it cannot use the direct digital key to play the track.

Return

- Press **RETURN** on the remote control to return to the previous VCD disc MENU level. It is functional only for Video CD when PBC is switched on.

R/L/ST

You can use it to select the different audio modes.

- Press **R/L/ST** on the remote control repeatedly to select the following modes:

L → **R** → **L R** on the LCD represents channel left/channel right / dual channel on a bilingual VCD or mono left / mono right / stereo on single language VCD.

CD/VCD/MP3-CD

PLAYING A MIXED MODE DISC

This set can play a mixed mode disc.

- mixture of audio CD and MP3-CD
- mixture of other combination may not be operated normally.

1. By default, audio CD tracks will be read first.

- **L** **R** will be displayed.
- On TV screen, "MIX, CD-DA" will be displayed.

2. Press **MIX/SEL** (on the remote control) repeatedly to select other disc modes.

• **MP3-CD:**

- **MP3** is displayed.
- On TV screen, MP3 menu is displayed.

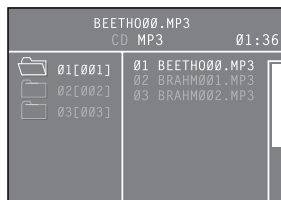

Note : - For protected CDs, "MIX CD-DA" is displayed on your TV screen even if the disc does not have other format. The **MIX/SEL** normal functions are not available for protected CDs.

CASSETTE PLAYBACK

1. Set the source selector to **TAPE/OFF**.
2. Press **■ ▲** to open the cassette holder.
3. Insert a recorded cassette.
4. Press **◀** and playback will start.
5. Adjust the sound using the **VOLUME** and **DBB** controls.
6. For brief interruptions, press **II**. Press **II** again to resume playback.
7. By pressing **◀◀** or **▶▶**, fast winding of the tape is possible in both directions.
8. To stop playback, press **■ ▲**
→ The keys are automatically released at the end of the tape.
9. Set the source selector to **TAPE/OFF** position (with the cassette keys are released) to switch off the set.

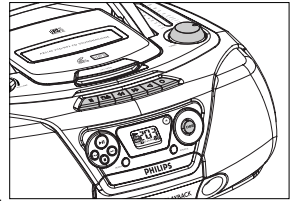

Note : - During playback, the keys are automatically released at the end of a tape and the set is switched off (unless PAUSE mode **II** has been activated.)

- During fast forwarding/rewinding, the keys will not be released at the end of a tape. To switch off the set, make sure the cassette keys are also released.

CASSETTE RECORDING

General information on cassette recording

- Recording is permissible insofar as copyright or other rights of third parties are not infringed.
- This deck is not suitable for recording on CHROME (IEC II) or METAL (IEC IV) type cassettes. For recording you should use NORMAL type cassettes (IEC I) on which the tabs have not been broken.
- Check and tighten slack tape before use with a pencil to avoid jamming the deck mechanism.
- The recording level is set automatically.

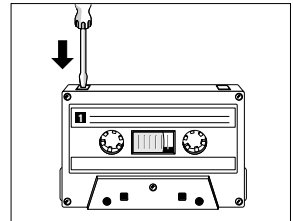

Note : - No recording will take place during the 7 seconds in the beginning of the tape.

- To prevent the accidental erasure of a recording, keep the cassette side to be safeguarded in front of you and break out the left tab. Recording on this side is no longer possible.

The making of unauthorized copies of copy-protected material, including computer programmes, files, broadcasts and sound recordings, may be an infringement of copyrights and constitute a criminal offence. This equipment should not be used for such purposes.



Be responsible
Respect copyrights

CASSETTE RECORDER

RECORDING FROM THE RADIO

1. Set the source selector to **FM** or **MW**.
2. Tune to the desired radio station using the **TUNING** knob.
3. Press **■▲** to open the cassette holder.
4. Insert a blank tape.
5. Press **●** to start recording.
6. For brief interruptions, press **||**. To resume recording, press **||** again.
7. To stop recording, press **■▲**.

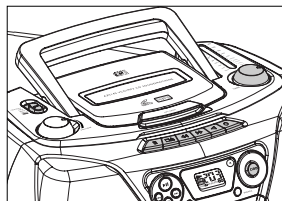

SYNCHRO START CD RECORDING

1. Set the source selector to **CD•VCD**.
2. Insert a CD and if desired, programme track numbers.
3. Press **■▲** to open the cassette holder.
4. Insert a blank cassette.
5. Press **●** to start recording.
→ Playing of the CD programme starts automatically from the beginning of the programme.
6. For brief interruptions, press **||**. To resume recording, press **||** again.
7. To stop recording press **■▲**.

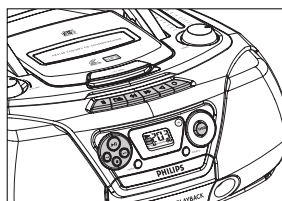

To select and record a particular passage within a track

1. Press and hold **◀◀** or **▶▶** on the set to select a passage.
→ Recording will start from this exact point when you press **●**.
2. Put the CD player in **||** position at the selected passage.
3. Press **▶||** to start recording.

TAPE DECK MAINTENANCE

To ensure a good recording and playback of the tape deck, clean parts (A), (B) and (C) show in the diagram below, after approx. 50 hours of operation, or on average once a month. Use a cotton bud slightly moistened with alcohol or a special head cleaning fluid to clean the deck.

- Open the cassette holder by pressing **■▲**.
- Press **◀** and clean the rubber pressure rollers (C).
- Press **||** and clean the magnetic heads (A) and also the capstans (B).
- After cleaning, press **■▲**.

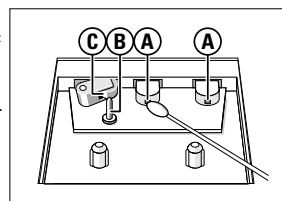

Cleaning of the heads can also be done by playing a cleaning cassette through once.

PRECAUTIONS & GENERAL MAINTENANCE

- Place the set on a hard, flat surface so that the system does not tilt.
- Always shut the CD door to keep the CD compartment dust-free. To clean the dusted compartment with a soft dry cloth.
- The mechanical parts of the set contain self-lubricating bearings and must not be oiled or lubricated.
- To clean the set, use a soft, slightly dampened chamois leather. Do not use any cleaning agents containing alcohol, ammonia, benzene or abrasives as these may harm the housing.
- Do not expose the system, batteries or discs to humidity, rain, sand or excessive heat (caused by heating equipment or direct sunlight). Always keep the disc tray closed to avoid dust on the lens.
- No objects filled with liquids, such as vases, shall be placed on the apparatus.
- The apparatus shall not be exposed to dripping or splashing.
- Adequate ventilation with a minimum gap of 15 cm between the ventilation holes and surrounding surfaces is necessary to prevent heat build-up.
- The ventilation should not be impeded by covering the ventilation openings with items, such as newspapers, table-cloths, curtains, etc.
- No naked flame sources, such as lighted candles, should be placed on the apparatus.

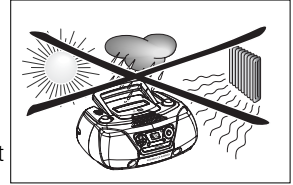

CD PLAYER AND CD HANDLING

- The lens of the CD player should *never be touched*.
- Sudden changes in the surrounding temperature can cause condensation to form and the lens of your CD player to cloud over. Playing a CD is then not possible. Do not attempt to clean the lens but leave the set in a warm environment until the moisture evaporates.
- Use only Digital Audio CDs.
- To take a CD out of its box, press the centre spindle while lifting the CD. Always pick up the CD by the edge and replace the CD back in its box after use to avoid scratching and dust.
- To clean the CD, wipe in a straight line from the centre towards the edge using a soft, lint-free cloth. Do not use cleaning agents as they may damage the disc.
- *Never write* on a CD or attach stickers to it.

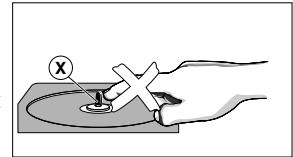

TROUBLESHOOTING

If a fault occurs, first check the points listed below before taking the set for repair.

If you are unable to remedy a problem by following these hints, consult your dealer or service centre.

WARNING: *Do not open the set as there is a risk of electric shock. Under no circumstances should you try to repair the set yourself, as this will invalidate the guarantee.*

Problem

Solution

CD/VCD OPERATION

"NO DISC" is displayed

- Insert a disc.
- Check if the disc is inserted upside down.
- Wait until the moisture condensation at the lens has cleared.
- Replace or clean the disc, see "Maintenance"
- Use a readable disc or correct recorded format MP3-CD.

No picture on TV screen

- Connect the cable between the system and TV.

No colour on TV

- Change the system to the respective PAL or NTSC setting.

RADIO RECEPTION

Radio reception is poor

- If the signal is too weak, adjust the antenna for better reception.
- Increase the distance between the Receiver and your TV or VCR.

TAPE OPERATION/RECORDING

Recording or playback cannot be made

- Clean deck parts, see "Maintenance".
- Use only NORMAL (IEC I) tape.
- Apply a piece of adhesive tape over the missing tab space.

GENERAL

The system does not react when buttons pressed/set does not work/no display on LCD.

- Slide the source sector to TAPE/OFF. Remove and reconnect the AC power plug for 30 seconds and switch on the set again.

Sound cannot be heard or is of poor quality

- Adjust the volume.
- Make sure the MP3-CD was recorded within 32-320 kbps (128kbps preferably) with sampling frequencies at 8 - 48 kHz (44.1kHz preferably).

The remote control does not function properly

- Reduce the distance between the remote control and the system.
- Insert the batteries with their polarities (+/- signs) aligned as indicated.
- Replace the batteries.
- Point the remote control in the direction of the system's IR sensor.